

Guidance on Ordinance Compliance in Illustrations

NOTE:

It is not the intent of this guidance on ordinance compliance to prevent approaches to graywater plumbing not illustrated in the figures. There are many more ways to install graywater plumbing that would meet the intent of this ordinance. The following figures are provided for conceptual planning purposes only. The figures are not to scale and meant to simply provide guidance on possible approaches to dual drainage plumbing.

Contents

General Guidelines to Dual Drainage Plumbing	1
Dual Drainage Plumbing: Diverter valve in crawl space	2
Dual Drainage Plumbing: Fixtures on upper floors	3
Dual Drainage Plumbing: Fixture(s) in concrete slab foundation	5
Dual drainage piping for clothes washer graywater systems	7
Overview of a gravity-flow, branched drain system.....	9
Overview of a pumped graywater to irrigation system	10
Additional Resources	11

General Guidelines to Dual Drainage Plumbing

- Graywater plumbing may combine flows from multiple approved fixtures.
- Master shower/bath is the preferred graywater source because it is the most reliable source of graywater.
- Lavatory sinks are the least preferred graywater source due to the small quantity and lower quality of graywater produced.
- For single-family dwellings with three or more full bathrooms, one shower/bath located in a less frequently used bathroom should be left off the graywater dual drainage plumbing system.
- For multi-family residential buildings, showers/baths located on the second floor or higher should be considered for additional graywater diversion.
- When feasible, locate diverter valves where they can be operated manually in an accessible location. Manually operated valves use fewer resources and cost less than electronically operated valves. Electronically operated valves should be considered when the location of the diverter valve in a crawl space is more than 20 feet from a crawl space access panel or entrance.
- A backwater valve is typically installed downstream of the diverter valve on horizontal piping before connection to the building's main blackwater drain to avoid contamination of graywater by blackwater. A backwater valve must be accessible for inspection and maintenance. A backwater valve is not required for a "laundry-to-landscape" clothes washer graywater system that does not alter drainage plumbing.
- Graywater dual drainage pipes(s) should be plumbed as high as possible under the building to allow graywater to drain at 1/4 inch per 12 inches of slope from the graywater diverter valve to the main blackwater drain and to the graywater stub-out.
- Where new drainage piping will be covered with a new slab, a diverter valve should be provided in the floor or exterior of the dwelling, with an exterior graywater stub-out (see Figure 3).
- Notes on the graywater stub-out:
 - The graywater stub-out should be located outside of the building so that graywater may be distributed to a future irrigation system by gravity to mulch basins. The use of pumped graywater systems increases project cost, maintenance burden, and energy use.
 - The graywater stub-out should be located near and above the building's main blackwater pipe such that the overflow pipe from a graywater pump basin can drain to the main blackwater pipe at 1/4 inch per 12 inches of slope.
 - Label all graywater piping in accordance with the current chapter of the California Plumbing Code regulating graywater. Label should read: "CAUTION: NON-POTABLE GRAYWATER, DO NOT DRINK" every five feet.

Dual Drainage Plumbing: Diverter valve in crawl space

Figure 1 illustrates graywater being collected from a first-floor shower/bath, with the diverter valve located in the crawlspace or basement.

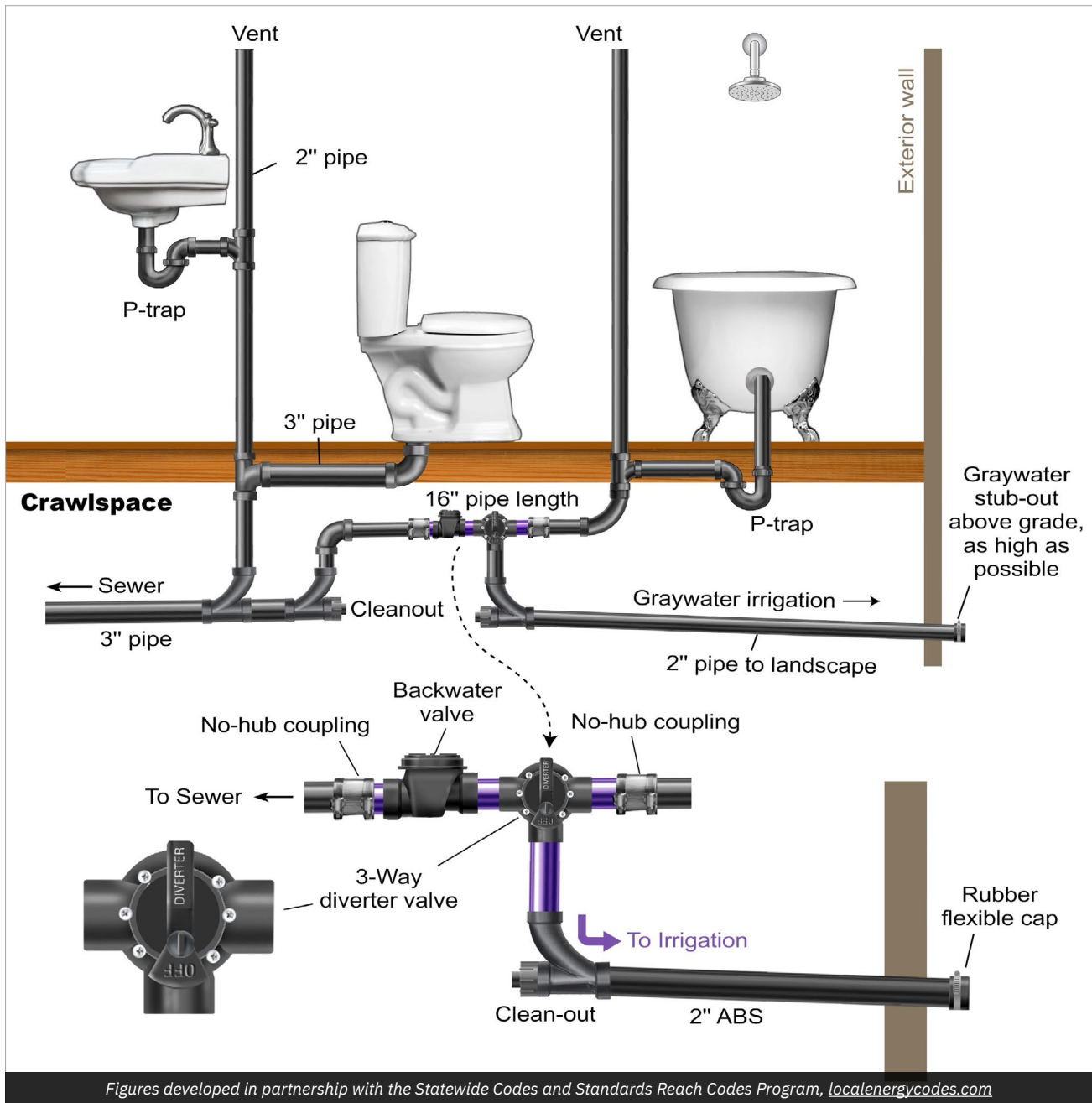

Figure 1. Dual Drainage Plumbing: Diverter Valve in Crawl Space

Dual Drainage Plumbing: Fixtures on upper floors

Figure 2a shows graywater being collected from a second-story shower/bath, with the diverter valve located below the bathroom inside the wall of the first floor.

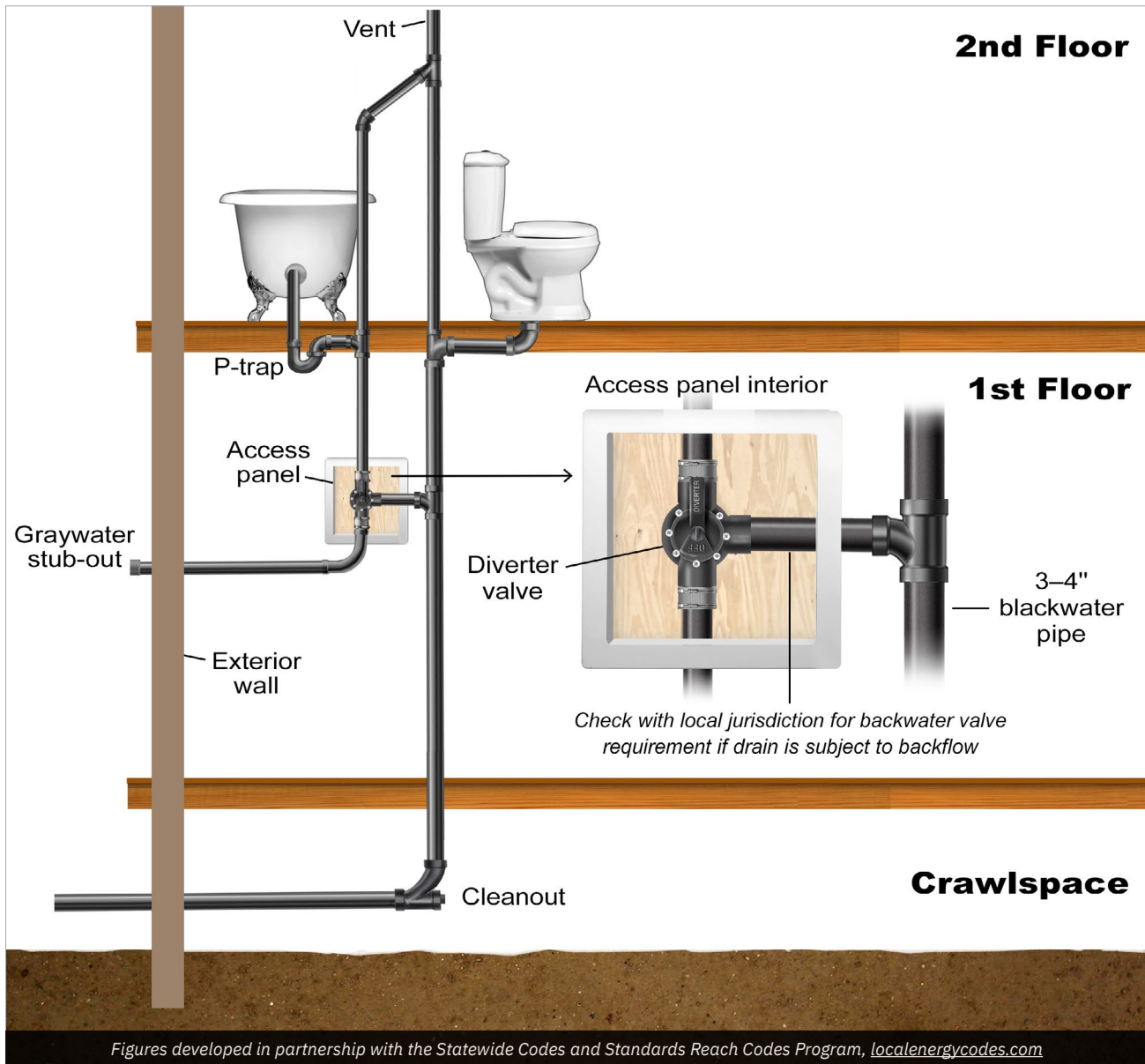

Figure 2a. Dual Drainage Plumbing: Single fixture on second floor near exterior wall

An access panel in the wall enables access to the diverter valve from inside the house. The main benefit to installing the diverter valve in the wall instead of in the ground or crawlspace is to allow the valve to be turned manually, instead of with a remote actuator, for a future gravity flow graywater irrigation system. The graywater stub-out is located on the exterior wall, avoiding dual drainage plumbing in the crawl space. This configuration is applicable for fixtures located near an exterior wall.

Figure 2b shows the same plumbing set-up as installed in Figure 2a, except the shower/bath drain pipe runs through the first floor and into the crawlspace. The graywater stub-out is located outside of the exterior crawl space foundation wall or crawl space vent, above grade. This configuration may be applicable when fixtures are located in the interior of the building and a stub-out can't be piped easily through an exterior wall above floor level.

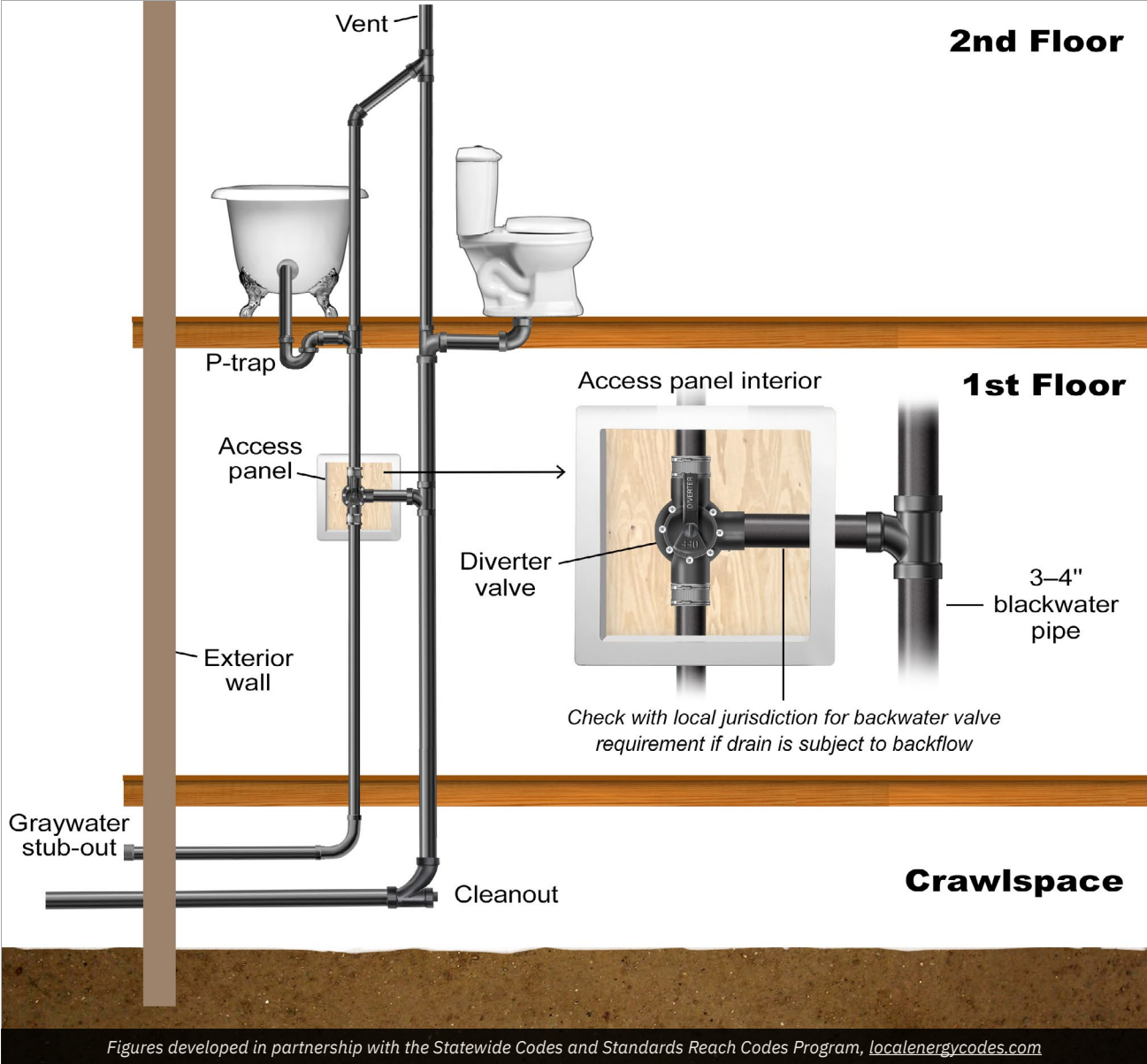

Figure 2b. Dual Drainage Plumbing: Single fixture on second floor with stub-out above grade, from crawlspace under the first floor

Dual Drainage Plumbing: Fixture(s) in concrete slab foundation

Figure 3a shows graywater diversion from the shower/bath and clothes washing machine in a house with a slab-on-grade foundation, where the diverter valve is located outside the building envelope in a subsurface enclosure (i.e., an irrigation valve box). The subsurface enclosure containing the diverter valve needs to be permanently accessible (i.e., no structures or hardscape covering it). The diverter valve should be positioned as high as possible in the enclosure to ensure graywater can drain at a 1/4 inch per 12 inch slope into a future gravity irrigation system or pump basin.

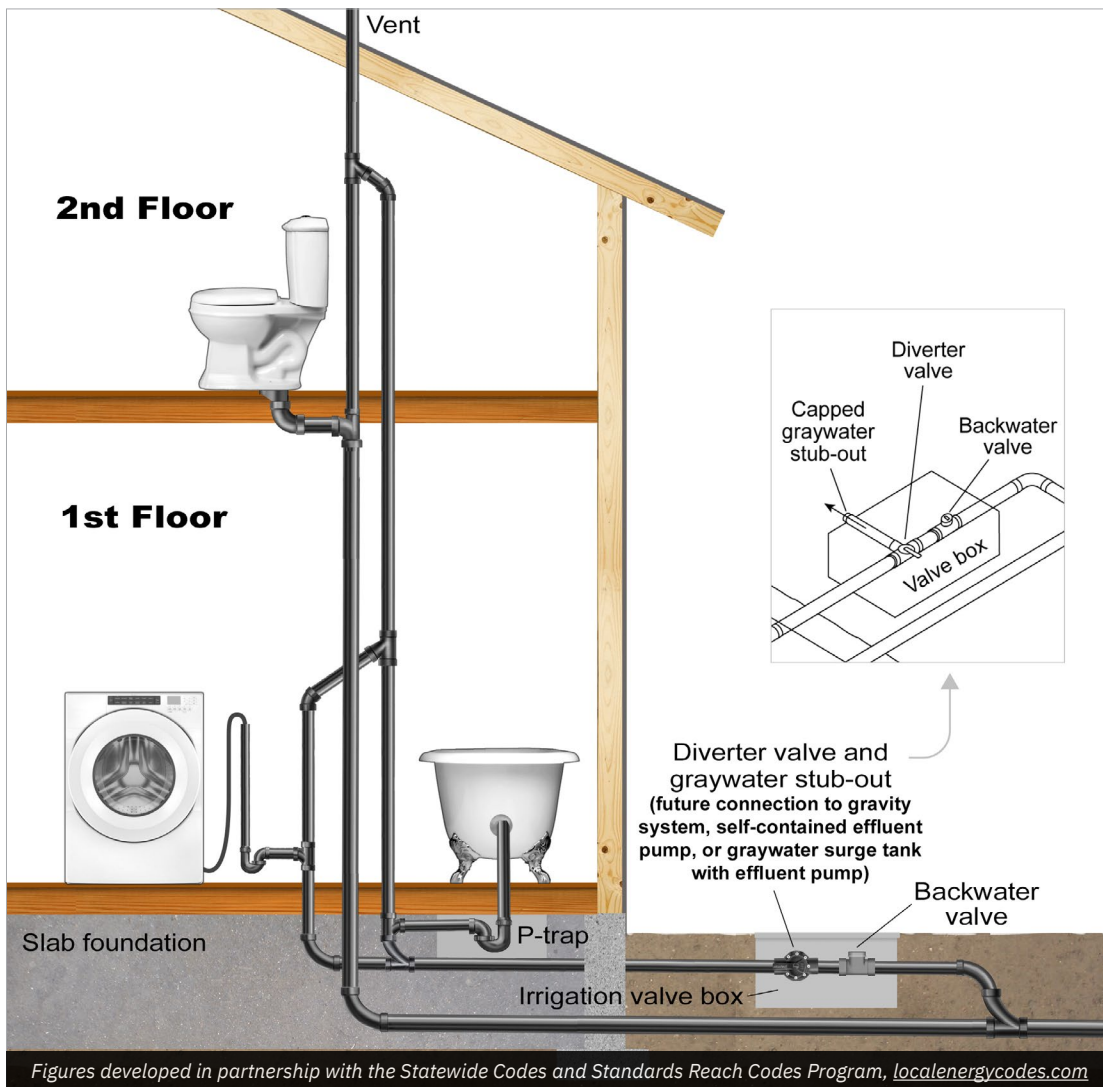
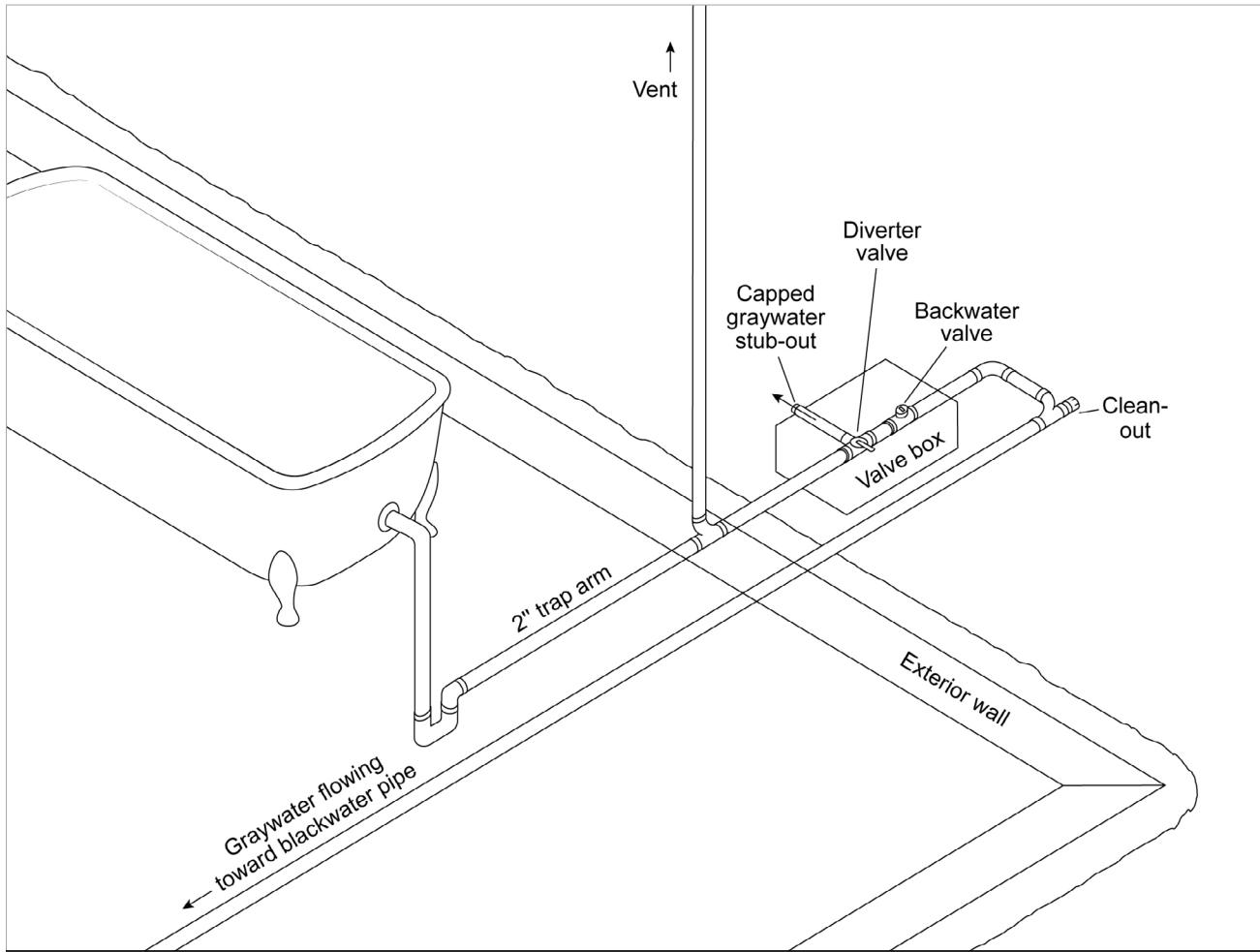

Figure 3a. Dual Drainage Plumbing: Multiple fixtures on concrete slab foundation

For a pumped graywater system, a self-contained effluent pump or graywater surge tank with effluent pump (see Figure 6) will need to be installed near the stub-out to pump graywater to the landscape. To ensure power is available for the effluent pump, an electrical outlet should be located within 10 feet of the graywater stub-out.

The graywater pipe returning to the sewer/blackwater pipe may be piped back into the building to connect into a blackwater drain inside the slab or in the crawlspace, as seen in Figure 3b.

Figure 3b demonstrates how to make graywater from a tub/shower (or other fixture) accessible when the bathroom is on a slab and the main drain is in another area of the building. The tub/shower drain has been directed through the slab and perimeter foundation to a subsurface enclosure (i.e., an irrigation valve box). A diverter valve and backwater valve are located in the box, providing a graywater stub out. The tub/shower drain then loops back through the foundation and into the slab to proceed to where it connects with the building's other drainage piping. 1/4 inch per 12 inches of slope must be carefully maintained on this loop piping.



Figures developed in partnership with the Statewide Codes and Standards Reach Codes Program, localenergycodes.com

Figure 3b. Dual Drainage Plumbing: Graywater drain extends outside slab for access, then returns into slab to join other drainage plumbing

Dual drainage piping for clothes washer graywater systems

Figure 4a illustrates laundry-to-landscape piping in a building with a crawl space.

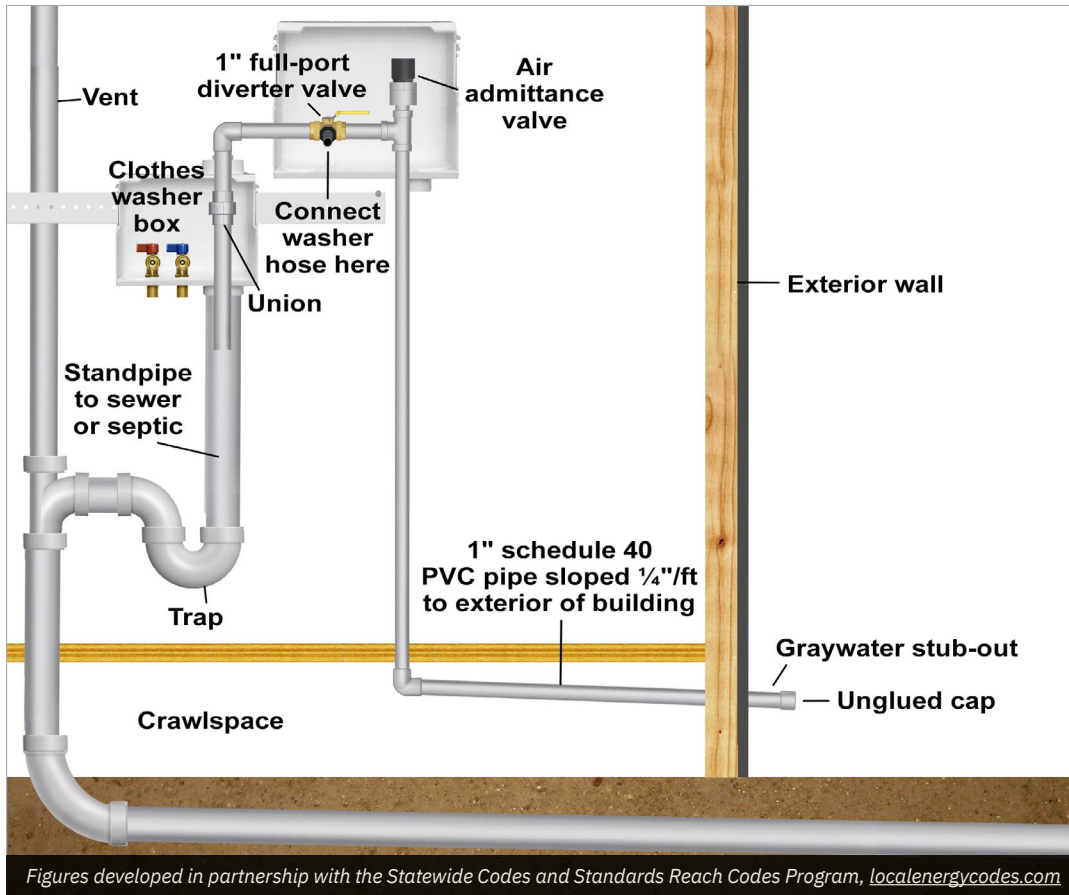

Figure 4a. Dual drainage piping for clothes washer graywater system where graywater irrigation pipe is run through crawlspace

A 3-way diverter valve is mounted to the wall in an access panel and connected directly to the discharge hose of the clothes washer.

Sewer/ Septic side of 3-way diverter valve: One inch piping extends from one side of the diverter valve into the standpipe in the clothes washer box, sending the graywater into the sewer or septic system. A union located on the one inch pipe inside the clothes washer box allows for disconnection and servicing of the standpipe.

Irrigation side of 3-way diverter valve: The other side of the diverter valve sends the graywater in one inch pipe through the floor into the crawlspace. From there the one inch piping extends outside creating a graywater stub out on the exterior of the building, for a future graywater irrigation system. The stub-out is covered with an unglued cap. An air admittance valve, which prevents accidental siphoning of the washing machine, should be placed at the highest elevation of the piping on the irrigation side of the diverter valve.

The one inch pipe is NOT part of the drain-waste-vent system of the house and is exempt from state codes for drainage plumbing. The one inch pipe should NOT have a trap or vent.

Figure 4b illustrates laundry to landscape piping in a slab on grade building. A diverter valve is mounted to the wall in an access panel and connected directly to the discharge hose of the clothes washer.

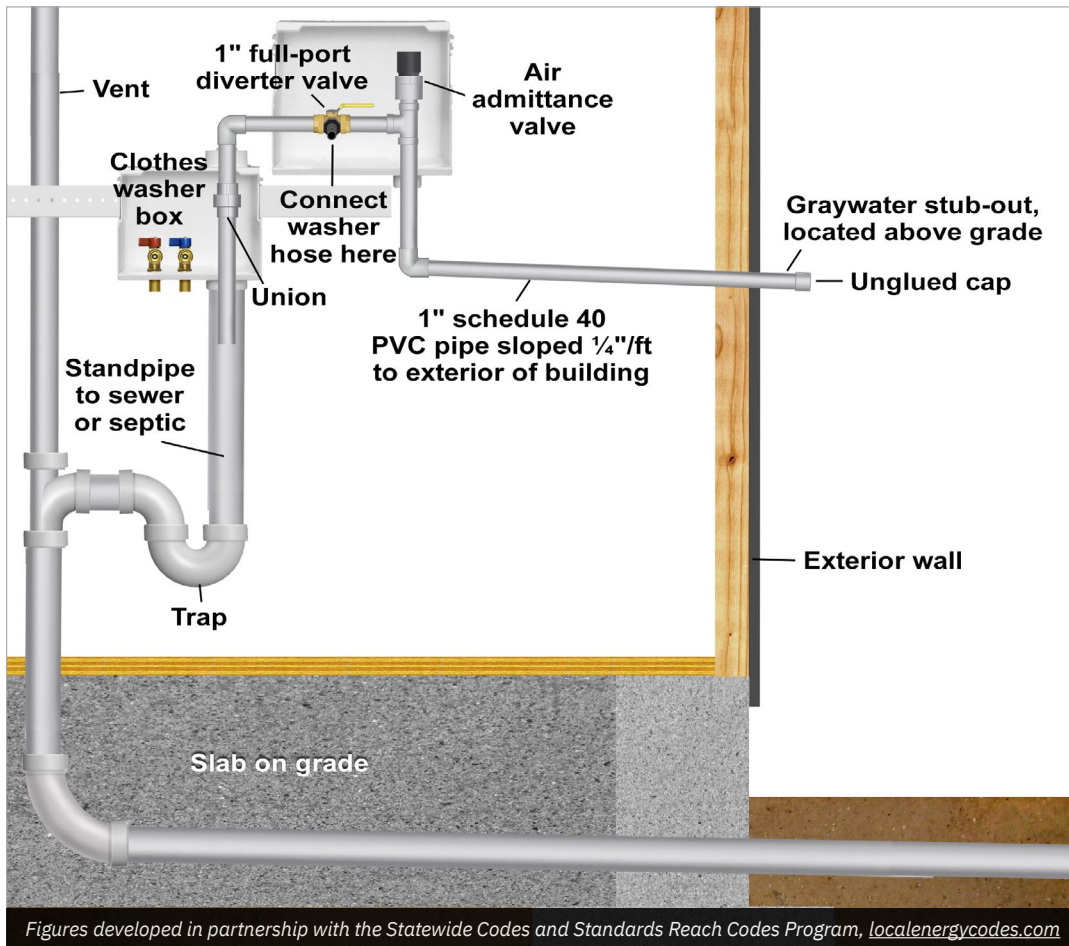

Figure 4b. Dual drainage piping for clothes washer graywater system where clothes washer is near an exterior wall or on a concrete slab foundation

Sewer/ Septic side of 3-way diverter valve: One side of the diverter valve sends graywater through a one inch pipe into the standpipe opening in the clothes washer box. A union located on the one inch pipe inside the clothes washer box allows for disconnection and servicing of the standpipe.

Irrigation side of 3-way diverter valve: The other side of the diverter valve is outfitted with one inch rigid pipe (for example Schedule 40 PVC) which extends through the exterior wall to a graywater stub-out. An unglued cap closes off the graywater stub-out. An air admittance valve, which prevents accidental siphoning of the washing machine, should be placed at the highest elevation of the piping on the irrigation side of the diverter valve.

The one inch pipe is NOT part of the drain-waste-vent system of the house and is exempt from state codes for drainage plumbing. The one inch pipe should NOT have a trap or vent.

Overview of a gravity-flow, branched drain system

Figure 5 demonstrates a conceptual image of how a gravity-flow, branched drain graywater system transports graywater to multiple landscape plants without a storage tank or pump.

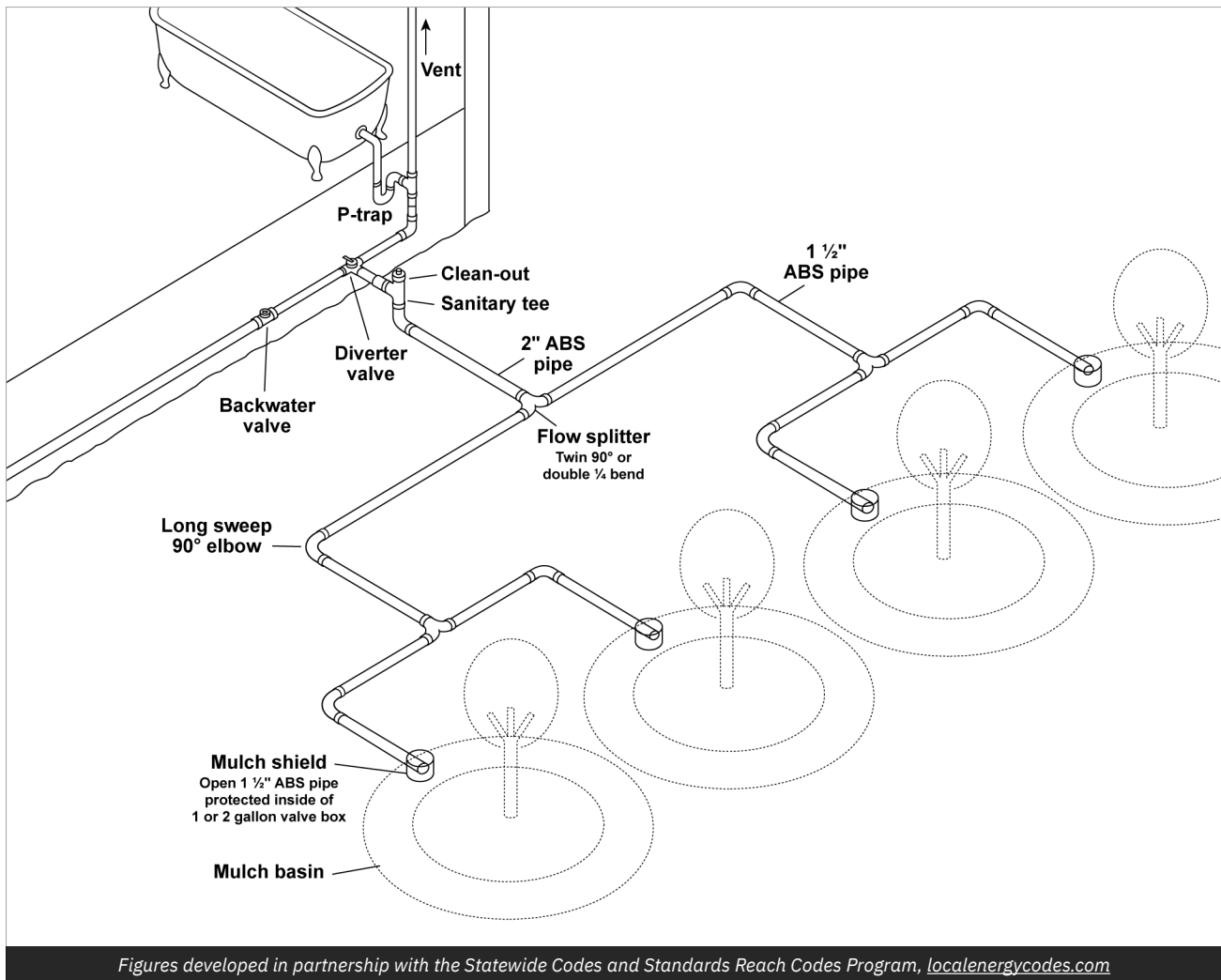
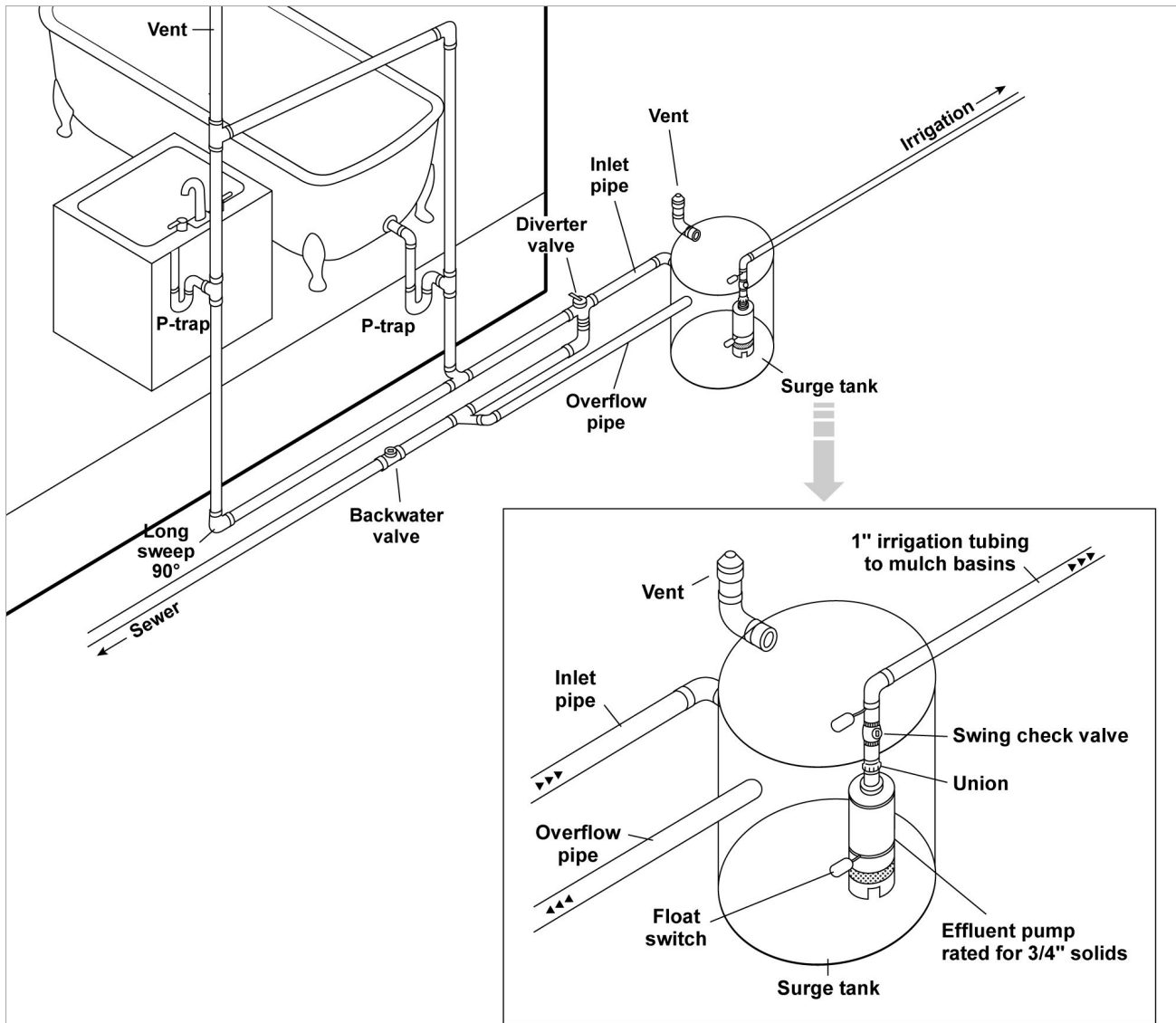

Figure 5. Overview of a gravity-flow, branched drain system

Note that a finished system would have buried piping and filled-in mulch basins. ABS pipe is used to convey graywater by gravity to mulch basins. On flat lots, the pipe should initially be buried as shallow as possible since the pipe will be progressively deeper the farther it travels from the house to maintain a minimum 1/4" per 12" slope.

Overview of a pumped graywater to irrigation system

Figure 6 shows graywater from a lavatory and tub/shower being made available for irrigation.



Figures developed in partnership with the Statewide Codes and Standards Reach Codes Program, localenergycodes.com

Figure 6. Overview of a pumped graywater to irrigation system

Note: Check with AHJ for surge tank venting requirements

A diverter valve installed in the drainage plumbing provides the option of directing the graywater to a graywater surge tank. From there, a float activated effluent pump pushes the graywater through one inch tubing to mulch basins in the garden. The surge tank must have a vent (consult local jurisdiction for particular requirements) and an overflow that allows graywater to flow by gravity to the drainage plumbing system in the event of pump failure. A backwater valve on the overflow pipe prevents any blackwater from backing up into the graywater plumbing or surge tank.

Additional Resources

These resources provide more information on state regulations and design and installation of graywater systems.

1. CA plumbing code: up.codes/viewer/california/ca-plumbing-code-2019
Check dgs.ca.gov/BSC/Codes for the most up-to-date building standards code
2. SFPUC L2L manual: sfwater.org/index.aspx?page=100
3. California Onsite Water Association (COWA): cowa.org
4. Greywater Action: greywateraction.org
5. Ecology Action / Central Coast Greywater Alliance: ecoact.org and centralcoastgreywater.org

Acknowledgements

Ecology Action and Greywater Action provided crucial guidance on the creation and delivery of this document and its enclosed illustrations. Links to both organizations' websites are available above, where you can learn more about their work in water efficiency.



Ecology Action's mission is to provide innovative energy, water, and transportation solutions to communities across California to reduce greenhouse gas emissions, at scale. In the more than 50 years since its launch, Ecology Action has grown into an industry leader that empowers individuals and organizations to make positive changes for a healthier, more equitable, low-carbon future.



Greywater Action is a collaborative of educators who teach residents and tradespeople about affordable and simple household water systems that dramatically reduce water use and foster sustainable cultures of water. The Greywater Action team works with policymakers and water districts to develop codes and incentives and has led thousands of people through greywater system design and construction.